



Mortice locks
for timber doors

DORMA

DORMA mortice locks for timber doors – a complete range of high quality models

| | Standard range | Standard range | Project range | Premier range | Emergency escape locks | |
|---|---|---|---|---|--------------------------------|--|
| Lock No. | 771 | 752-F | 151 | 151-F | 180/181/182 | |
| Features | technically as per DIN 18251, Class 3 | technically as per DIN 18251, Class 3 | technically as per DIN 18251, Class 3 | technically as per DIN 18251, Class 3 | as per DIN 18250 Class 4 | |
| Bolt projection (mm) | double throw,20 | double throw,20 | double throw,20 | double throw,20 | double throw,22 | |
| Backset D (mm) | 55 | 55 | 55, 60, 65, 70, 80 | 55, 60 | 55, 65, 100 | |
| Forend width (mm) | 20, 24 | 20, 24 | 20, 24 | 20, 24 | 20, 24 | |
| Latchbolt and deadbolt position | central non-handed | central non-handed | central non-handed | central non-handed | ISO 5 or 6 | |
| Forend designs | | | | | | |
| square ends | ● | ● | ● | ● | | |
| radiused | ● | ● | ● | ● | ● | |
| Forend finishes | | | | | | |
| stainless steel, satin-brushed | ● | ● | ● | ● | ● | |
| for Europrofile cylinder | ● | ● | ● | ● | ● | |
| warded lever lock | | | ● | | | |
| for bathroom/WC (bolt projection 10 mm) | ● | ● | ● | ● | | |
| Recommended strike plates No. | 20 | 20 | 20 | 20 | 20 | |
| Page | 6 | 7 | 8 | 9 | 10 | |

Locks from DORMA offer the very highest standard of quality and functional reliability.

With the use of high-grade materials, precise production techniques and a comprehensive quality management system, all DORMA locks meet demanding technical specifications. Additionally, models conforming to the technical requirements of DIN 18251 also offer unbeatable ease of use and security features.

Further information, specification texts

Additional information, e.g. specification texts, drawings, and installation instructions on many products, can be accessed via electronic media (CD ROM, diskette, Internet). The codes beside the computer symbol  are the search terms. The specification texts are also available in printed form.

Accessories

Strike plates

Page

15

| | Latches | Dead-locks | Swing door locks | Sliding door locks | Hotel lock with anti-thrust function | Night latch lock with anti-thrust function |
|--|--|--------------------|--------------------|--------------------------------|--------------------------------------|--|
| | 115-F | 132-F | 484 | 401/403 | 210 | 117 |
| | available as project lock with self-adjusting clamp follower | | | | | |
| | | double throw,20 | double throw,20 | | double throw,21 | |
| | 55, 60 | 55, 60 | 55, 60, 65, 70, 80 | 55, or custom | 55, 60, 65 | 55, 60, 65 |
| | 20, 24 | 20, 24 | 24 | | 20, 24 | 20, 24 |
| | central non-handed | central non handed | central non handed | central non handed | ISO 5 or 6 | ISO 5 or 6 |
| | ● | ● | ● | ● | | |
| | ● | ● | ● | | ● | ● |
| | ● | ● | ● | ● | ● | ● |
| | | ● | ● | ● | ● | ● |
| | | | | | | |
| | | | | | | |
| | 23 | 21 | 26/27, 26/1 26/2 | included in standard equipment | 20 | 23 |
| | 9 | 9 | 11 | 12 | 13 | 14 |

● standard equipment

Internal door locks 771



– for Europrofile cylinder

Page 6

Internal door locks 752-F



– for Europrofile cylinder

Page 7

Projekt Range 151

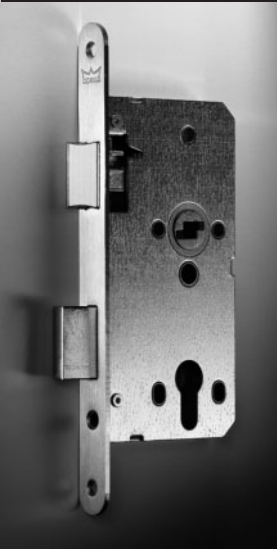

– for Europrofile cylinder
– for bathroom/WC

Page 8

Premier Range 151-F

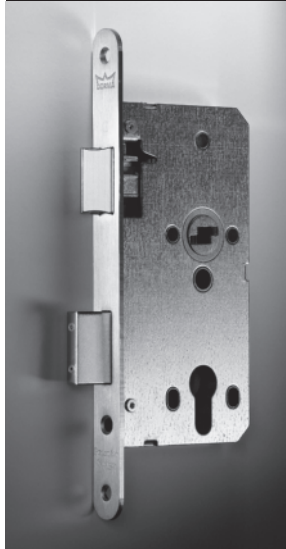

– for Europrofile cylinder
– for bathroom/WC

Page 9

Latches 115-F



with standard lock case:
– project lock with self-adjusting clamp follower

Page 9

Deadlocks 132-F



with standard lock case:
– for Europrofile cylinder

Page 9

Antipanic locks 182

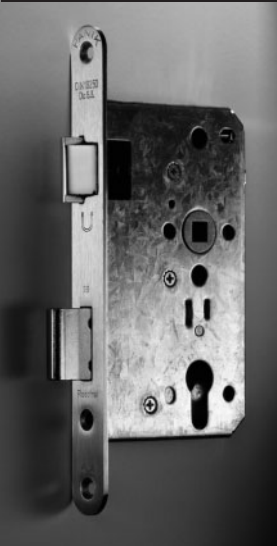

Emergency escape locks
– for Europrofile cylinder
– locks for fire and smoke check doors: 180
– emergency escape locks: 181, 182

Page 10

Swing action door locks 484



– for Europrofile cylinder

Page 11

Sliding door locks 401



- with pivoting hook bolt for Europrofile cylinder
- with pivoting hook bolt and follower
- with claw bolt for Europrofile cylinder

Page 12

Hotel locks 210



- for Europrofile cylinder

Page 13

Night latch 117



- with anti thrust function**
- for Europrofile cylinder

Page 14

Strike plates

see page 15

771, 775, 778, 779

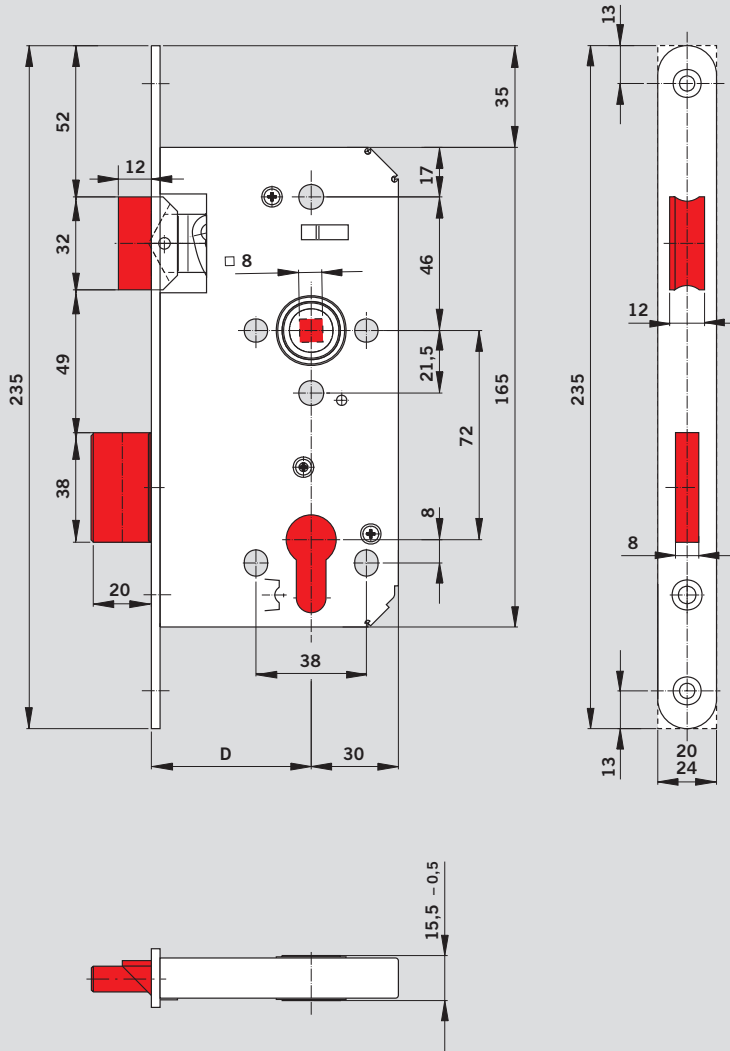

Design features

- Lock case sealed, zinc-plated
- Latchbolt and deadbolt nickel-plated
- Bolt projection double throw 20 mm
- 8 mm square follower
- Technical specifications to DIN 18251, Class 3
- Forend in centre, non-handed

Backset D (mm)
55

Forend width (mm)
20, 24

Forend design

- radiused
- square ends

Forend finishes

- stainless steel, satin-brushed



771

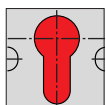

771

for Europrofile cylinder with key operated latch follower-to-keyway centres 72 mm

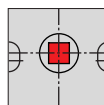

775

for bathroom/WC without key operated latch bolt projection 10 mm follower-to-keyway centres 78 mm

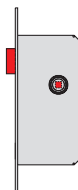

779

Latch

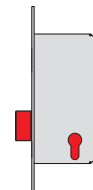

778

Deadlock for Europrofile cylinder

752-F, 790-F, 515-F, 532-F

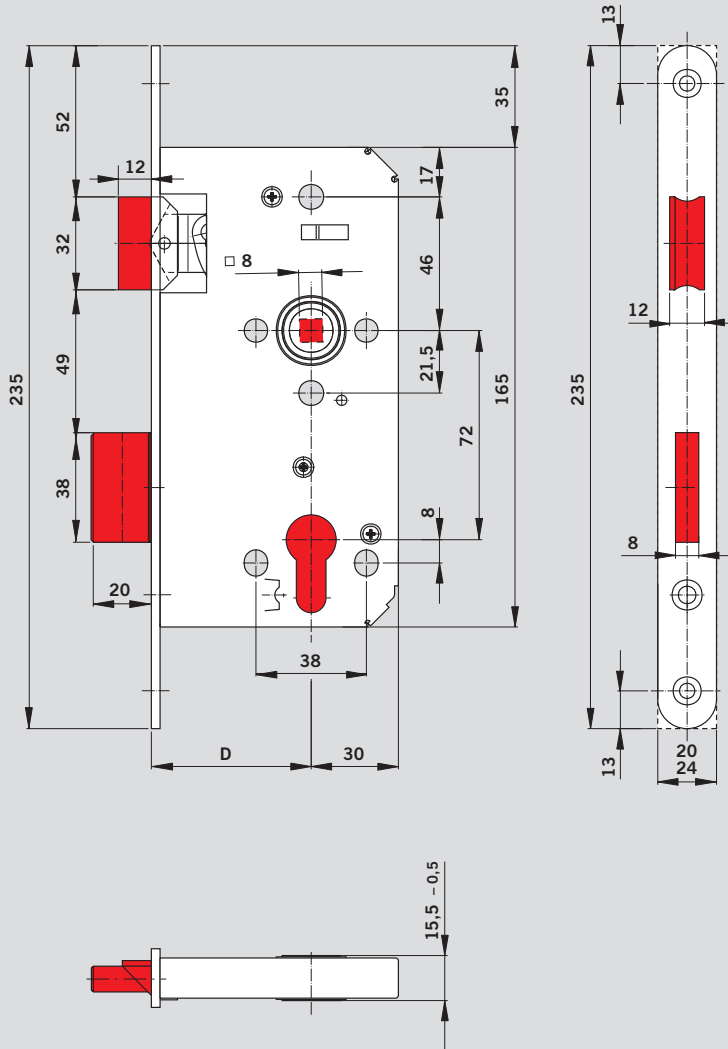

Design features

- Lock case sealed, zinc-plated
- Latchbolt and deadbolt steel, nickel-plated
- Bolt projection double throw 20 mm
- 8 mm square follower
- Technical specifications to DIN 18251, Class 3
- Forend in centre, non-handed

Backset D (mm)

55

Forend width (mm)

20, 24

Forend design

- radiused
- square ends

Forend finishes

- stainless steel, satin-brushed

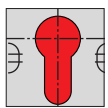
 752-F
**752-F**

for Europrofile cylinder
with key operated latch
follower-to-keyway
centres 72 mm

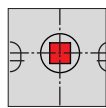
**790-F**

for bathroom/WC
without key operated latch
bolt projection 10 mm
follower-to-keyway
centres 78 mm

**515-F**

Latch

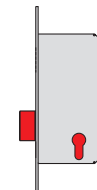
**532-F**

Deadlock
for Europrofile cylinder

151, 161, 191, 115, 132

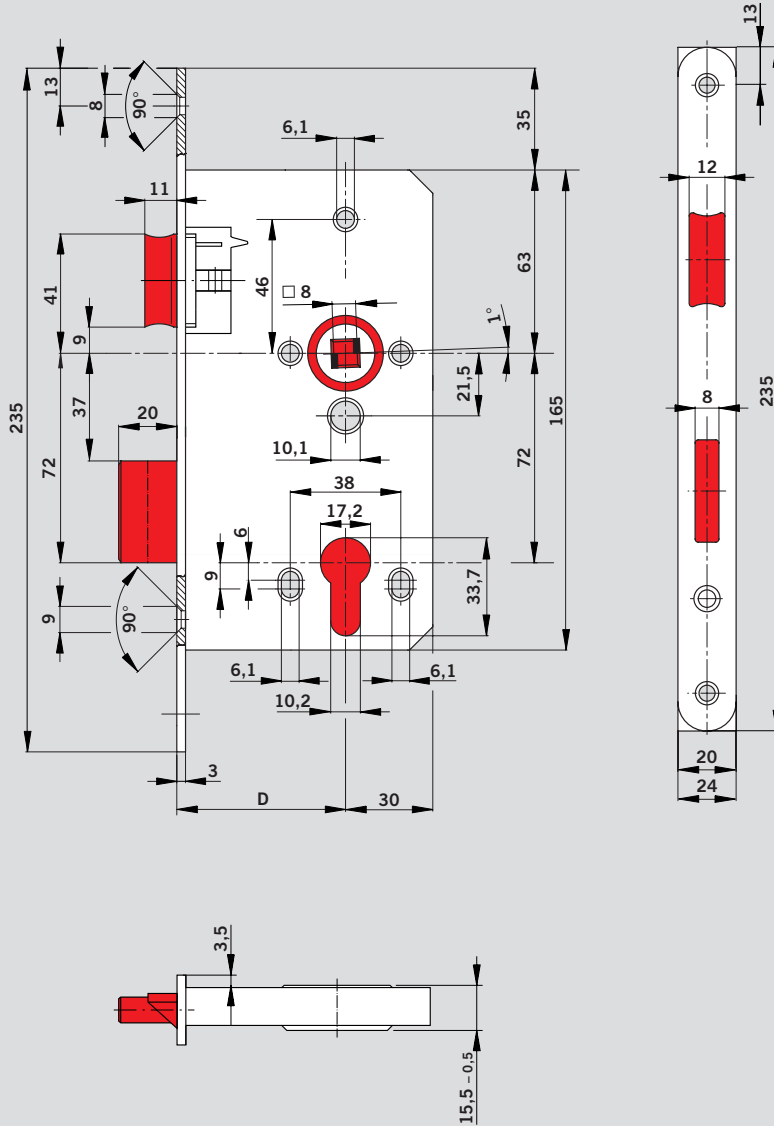

- Lock case sealed, zinc-plated
- Latchbolt and deadbolt nickel-plated
- Bolt projection double throw 20 mm
- 8 mm square follower
- Bronze bushed, self-adjusting follower
- Maintenance-free, pre-lubricated silent latch action
- Technical specifications to DIN 18251, Class 3

Backset D (mm)
55, 60, 65, 70, 80

Forend width (mm)
20, 24

Forend design
- square ends
- radiused

Forend finishes
- stainless steel,
- satin-brushed

 151

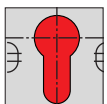

151
for Europrofile cylinder
with key operated latch
follower-to-keyway
centres 72 mm

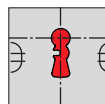

161
warded lever
without key operated
latch with 1 key,
follower-to-keyway
centres 72 mm

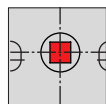

191
for bathroom/WC
without key operated
latch bolt projection
10 mm follower-to-keyway
centres 78 mm

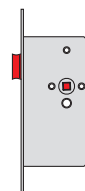

115
without key operated
latch

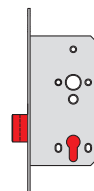

132
Deadlock for
Europrofile cylinder

151-F, 191-F, 115-F, 116-F, 132-F

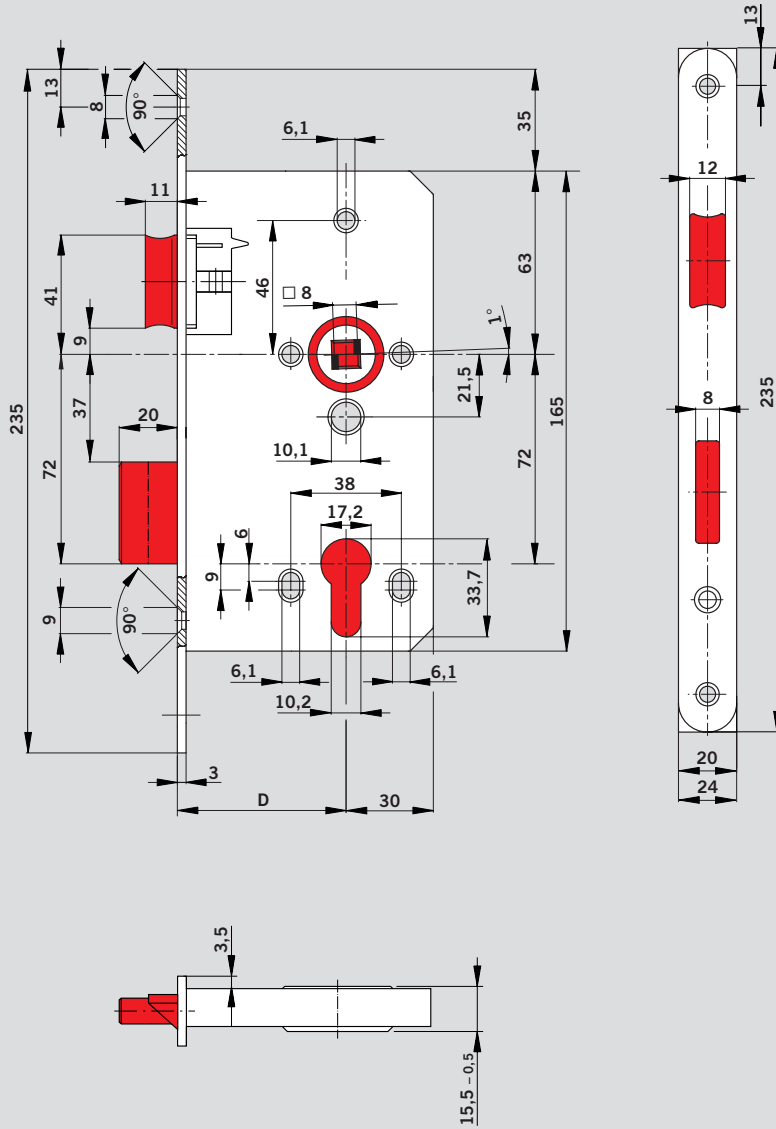

Design features

- Lock case sealed, zinc-plated
- Brass latch and brass bolt nickel-plated
- Bolt projection double throw 20 mm
- 8 mm square follower
- Bronze bushed, self-adjusting follower
- Maintenance-free, pre-lubricated silent latch action
- Specifications to DIN 18251, Class 3
- Forend in centre, non-handed

Backset D (mm)
55, 60

Forend width (mm)
20, 24

Forend design
- square ends
- radiused

Forend finishes
- stainless steel,
satin-brushed

151-F

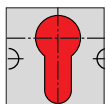

151-F
for Europrofile cylinder
with key operated latch
follower-to-keyway
centres 72 mm

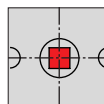

191-F
for bathroom/WC
without key operated latch
bolt projection 10 mm, follo-
wer-to-keyway centres 78 mm

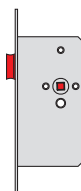

115-F
without key operated latch
116-F
with key operated latch
Project lock, bronze bushed,
self-adjusting clamp follower
for rattle-free lever handles

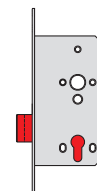

132-F
Deadlock
for Europrofile cylinder

180, 181, 182

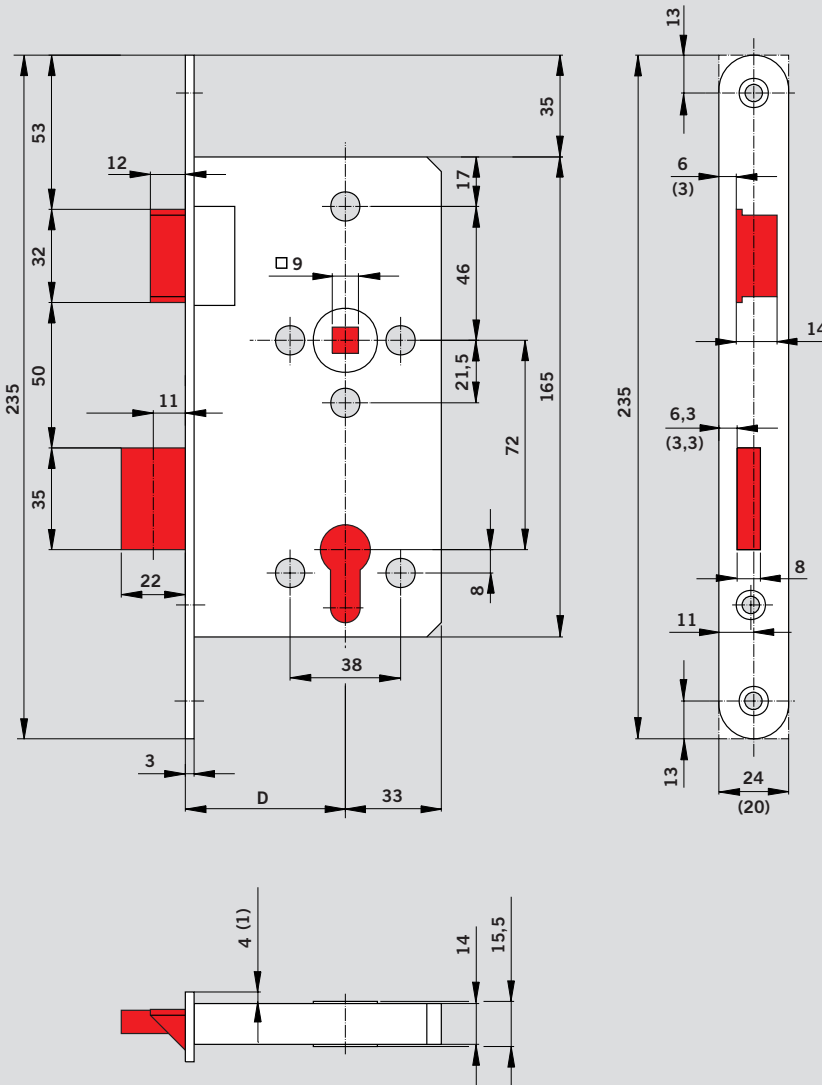

Design features

- Lock case sealed, zinc-plated
- Latchbolt and deadbolt nickel-plated
- Bolt projection double throw 22 mm
- 9 mm square follower
- Specifications in accordance with DIN 18250 for fire and smoke check doors

Backset D (mm)

55, 65, 100

Forend width (mm)

20, 24

Forend design

- radiused
- handed

Forend finishes

- stainless steel, satin-brushed

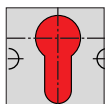

180

for fire and smoke check doors

9 mm square follower

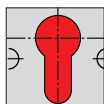

181

Escape lock and key operated latch

9 mm square follower

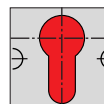

182

Escape lock with split 9 mm square follower

484

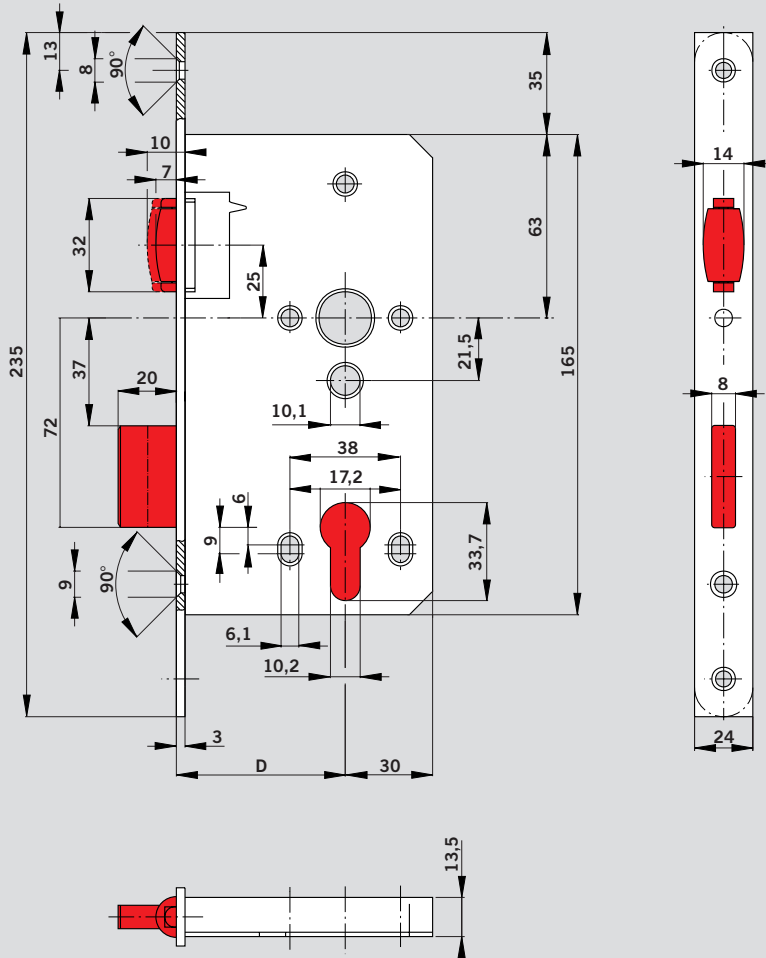

Design features

- Lock case sealed, zinc-plated
- Roller bolt of brass, adjustable
- Bolt nickel-plated
- Bolt projection double throw 20 mm
- Forend in centre, non-handed

Backset D (mm)
55, 60, 65, 70, 80

Forend width (mm)
24

Forend design

- square ends
- radiused

Forend finishes

- stainless steel, satin-brushed

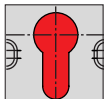
 484
**484**

for Europrofile cylinder

401, 402, 400

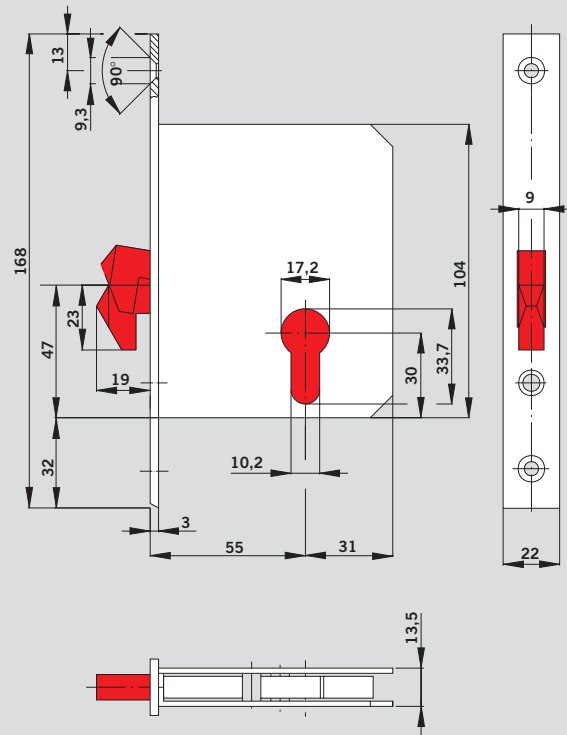

401

403, 404

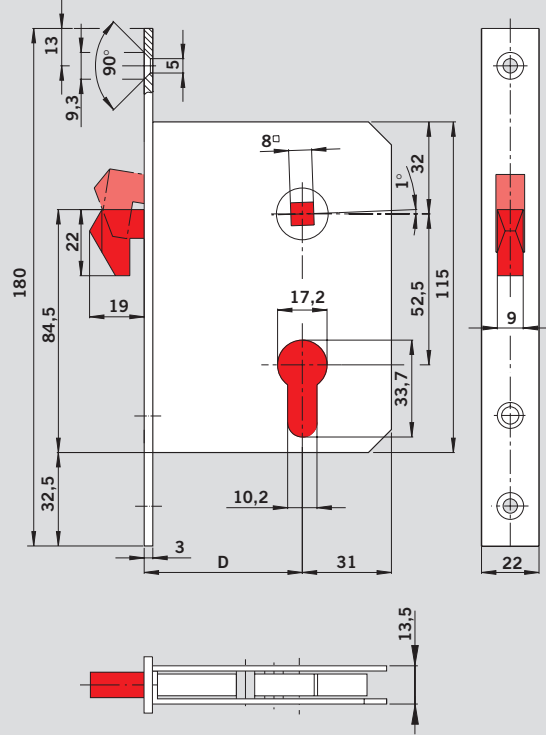

403

Design features

- Lock case thickness 14 mm (lock with claw bolt 15 mm)
- Mechanism height 10 mm (lock with claw bolt 11 mm)
- With steel latch spring
- Non-handed

Backset D (mm)
55

Forend width (mm)
22

Forend design
- square ends

Forend finishes
- stainless steel, satin-brushed

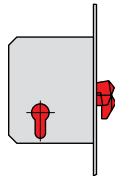

401
with pivoting hook bolt for Europrofile cylinder

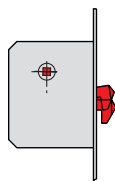

402
with pivoting hook bolt and follower
8 mm square follower

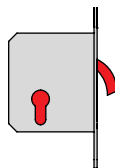

400
with claw bolt for Europrofile cylinder
forend width 22 mm

Design features

- 8 mm square follower
- lock case thickness 14 mm
- Mechanism height 10 mm
- Bolt, single throw
- With steel spring

Backset D (mm)
50, 55, 60, 65

Forend width (mm)
22

Forend design
- square ends

Forend finishes
- stainless steel, satin-brushed

Optional features

- For type 403**
- As warded lever lock with 1 key
 - Follower-to-keyway centres 56 mm

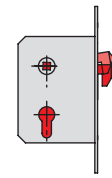

403
with pivoting hook bolt for Europrofile cylinder

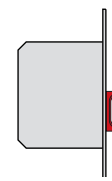

404
with ring pull

210

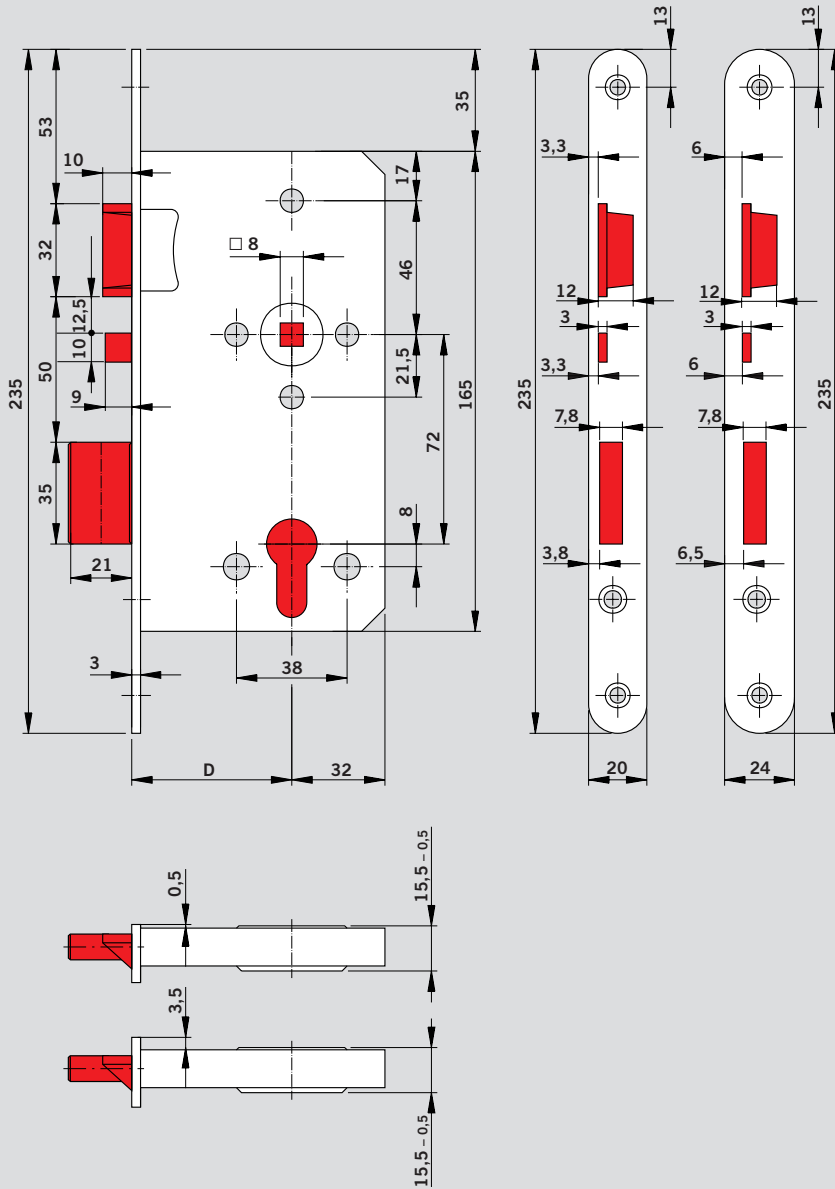

Design features

- Lock case sealed, zinc-plated
- Latch, deadlatching snib and steel deadbolt, nickel-plated
- Bolt projection double throw 21 mm
- 8 mm brass square follower
- Dimensions and specifications to DIN 18251

Backset D (mm)
55, 60, 65

Forend width (mm)
20, 24

Forend design

- radiused
- handed

Forend finish

- stainless steel, satin-brushed

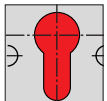
 210
**210**

for Europrofile cylinder
with key operated latch
follower-to-keyway
centres 72 mm

117

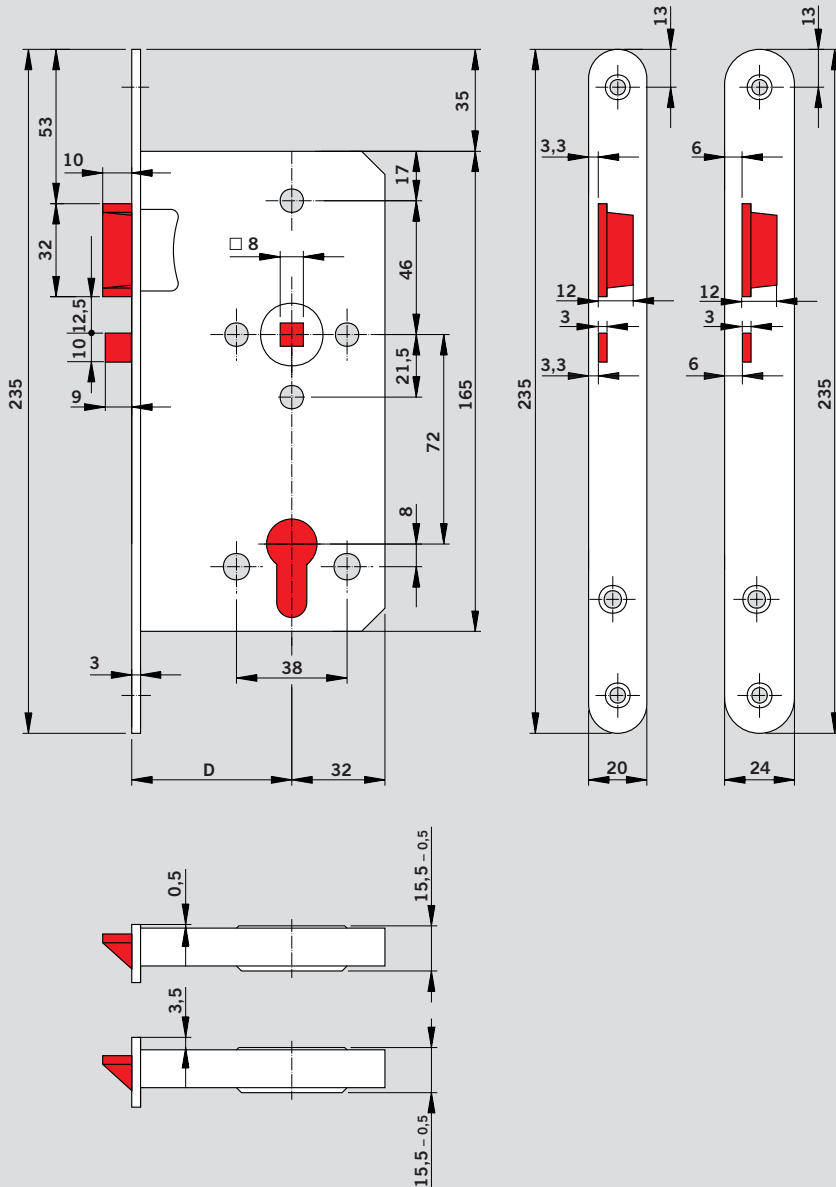
**Design features**

- Lock case sealed, zinc-plated
- Latch, deadlatching snib, nickel-plated
- 8 mm brass square follower
- Dimensions and specifications to DIN 18251

Backset D (mm)
55, 60, 65

Forend width (mm)
20, 24

Forend design

- radiused
- handed

Forend finish

- stainless steel, satin-brushed

117

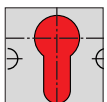
**117**

for Europrofile cylinder
with key operated latch
follower-to-keyway
centres 72 mm

Strike plates

20

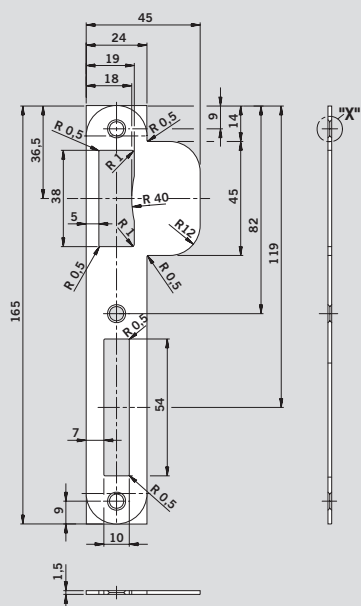

| Width: | Design | / Article No. |
|--------|---------------|---------------|
| 24 mm/ | square ends / | 20/1 |
| 45 mm | radiused / | 20/2 |

21

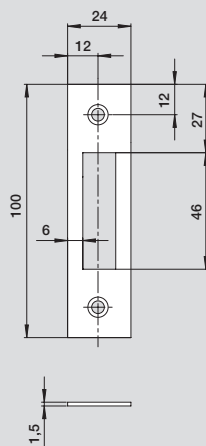

| Width: | Design | / Article No. |
|--------|--------------|---------------|
| 24 mm | square ends/ | 21 |

23

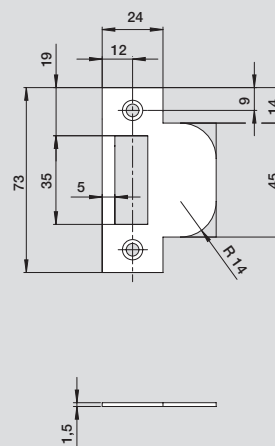

| Width: | Design | / Article No. |
|--------|---------------|---------------|
| 24 mm | square ends / | 23 |

www.dorma.com

Door Control Division worldwide

Central Europe

DORMA GmbH + Co. KG
Breckerfelder Str. 42-48
D-58256 Ennepetal
Tel. +49 23 33/7 93-0
Fax +49 23 33/7 93-4 95

Australia

DORMA Door Controls Pty. Ltd.
52 Abbott Road
Hallam/Victoria 3803
Australia
Tel. +61 3/97 96 35 55
Fax +61 3/97 96 39 55

China

DORMA Door Controls (Suzhou)
Co. Ltd.
No. 9, Hong Feng Road
Suzhou Singapore Industrial Park
Suzhou, 215021
P. R. of China
Tel. +86 512/67612481
Fax +86 512/67614582

DORMA Door Controls Pte. Ltd.
Room 701, Technology Plaza
651 King's Road
North Point
Hong Kong
Tel. +825/250 34632
Fax +825/288 75370

Emerging Markets

DORMA GmbH + Co. KG
Breckerfelder Str. 42-48
D-58256 Ennepetal
Tel. +49 23 33/7 93-0
Fax +49 23 33/7 93-4 95

DORMA Door Controls (Pty.) Ltd.
Kings Court, 4A Mineral Crescent
ZA-2000 Crown/Gauteng
South Africa
Tel. +27 11/8 30 02 80
Fax +27 11/8 30 02 91

Far East

DORMA Far East Pte. Ltd.
No. 31 Gul Lane,
Singapore 629425
Tel. +65 62 68/76 33
Fax +65 62 65/79 14

France

DORMA France S.A.S.
Europarc
42, rue Eugène Dupuis
F-94046 Créteil
Tel. +33 1/41 94 24 00
Fax +33 1/41 94 24 01

Gulf

DORMA Gulf Door Controls FZE
Jebel Ali Free Zone,
Roundabout 8,
Unit VC 02
Dubai, United Arab Emirates
Tel. +971 48/83 90 14
Fax +971 48/83 90 15

North America

DORMA Architectural Hardware
DORMA Drive, Drawer AC
Reamstown, PA 17567
Tel. +1-800-523-8483
Fax +1-800-274-9724

Scanbalt

DORMA Danmark A/S
Sindalvej 6 - 8
DK-2610 Rødovre
Tel. +45 44/54 30 00
Fax +45 44/54 30 01

South America

DORMA Sistemas de Controles
para Portas Ltda.
Av. Piracema, 1400
Centro Empresarial Tambore
CEP 06400 Barueri/
São Paulo, Brasil
Tel. +55 11/41 91 32 44
Fax +55 11/41 91 21 93

South-East Europe

DORMA AUSTRIA GmbH
Pebering Strass 22
A-5301 Eugendorf
Tel. +43 62 25/2 84 88
Fax +43 62 25/2 84 91

South Europe

DORMA Italiana S.r.l.
Via. A. Canova 44/46
I-20035 Lissone (MI)
Tel. +39 039/24 40 31
Fax +39 039/24 40 33 10
DORMA Ibérica, S.A.
Camino San Martin de la Vega, 4
E-28500 Arganda del Rey
(Madrid)
Tel. +34 91/8 75 78 50
Fax +34 91/8 75 78 81

UK/Ireland

DORMA UK Ltd.
Door Controls Division
Wilbury Way
GB-Hitchin
Hertfordshire SG4 0AB
Tel. +44 14 62/47 76 00
Fax +44 14 62/47 76 01

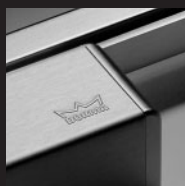

Door Control



Automatic



Glass
Fittings and
Accessories



Security/
Time and
Access (STA)



Movable
Walls